

Notice d'utilisation : CINTREUSE MANUELLE

Références :
400F89



Lire attentivement ce livret d'utilisation et d'entretien dans les moindres détails avant toute utilisation.
Conserver ce livret pour toute consultation ultérieure

Cintrage pour Ø 1/4", 5/16" et 3/8".

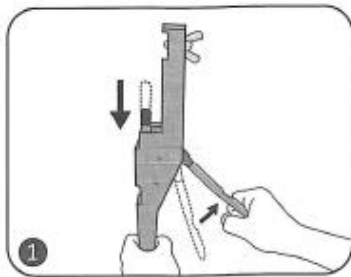
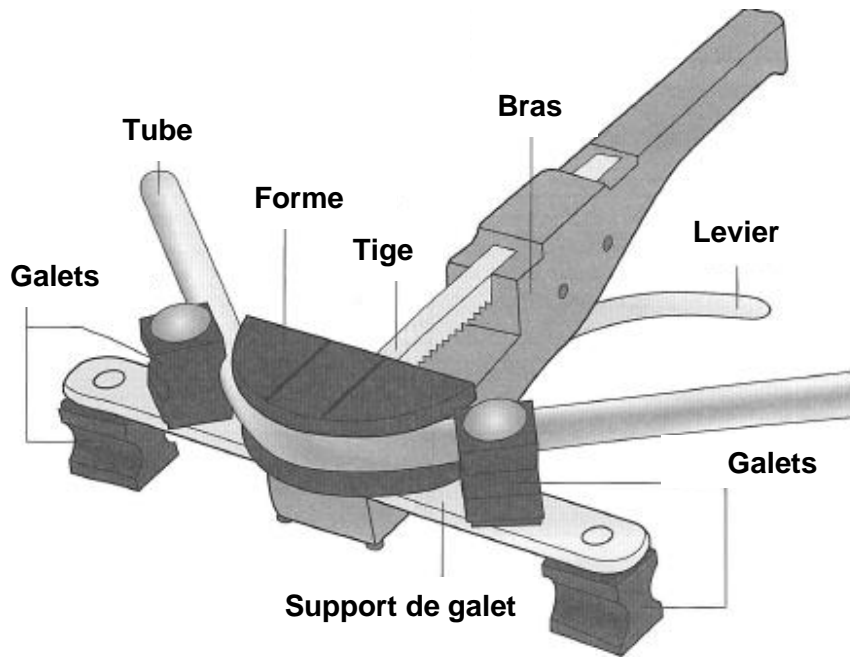

Relever le levier pour abaisser la tige.

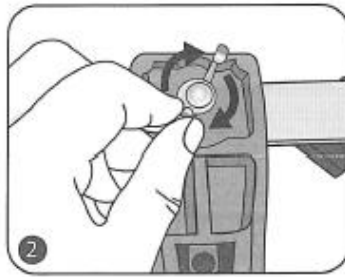

Mettre en place le support de galets.

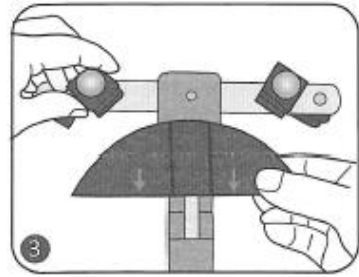

Mettre en place les galets.

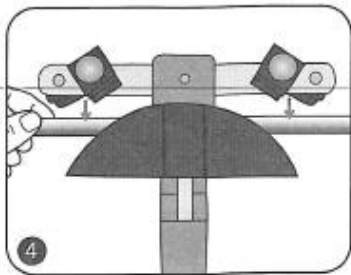

Mettre en place le tube, positionner les galets et amener la tige en butée.

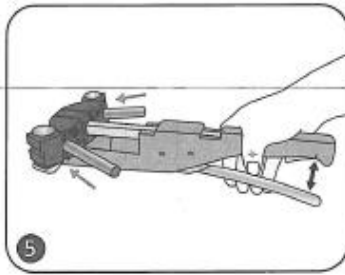

Procéder au cintrage.

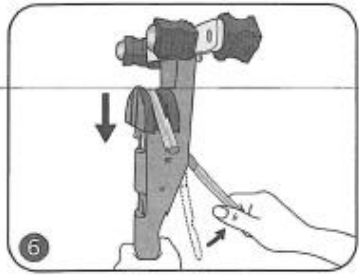

Relever le levier pour libérer le tube.

Cintrage pour Ø 1/2", 5/8", 3/4" et 7/8".

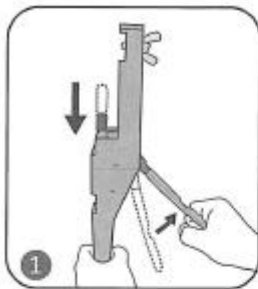
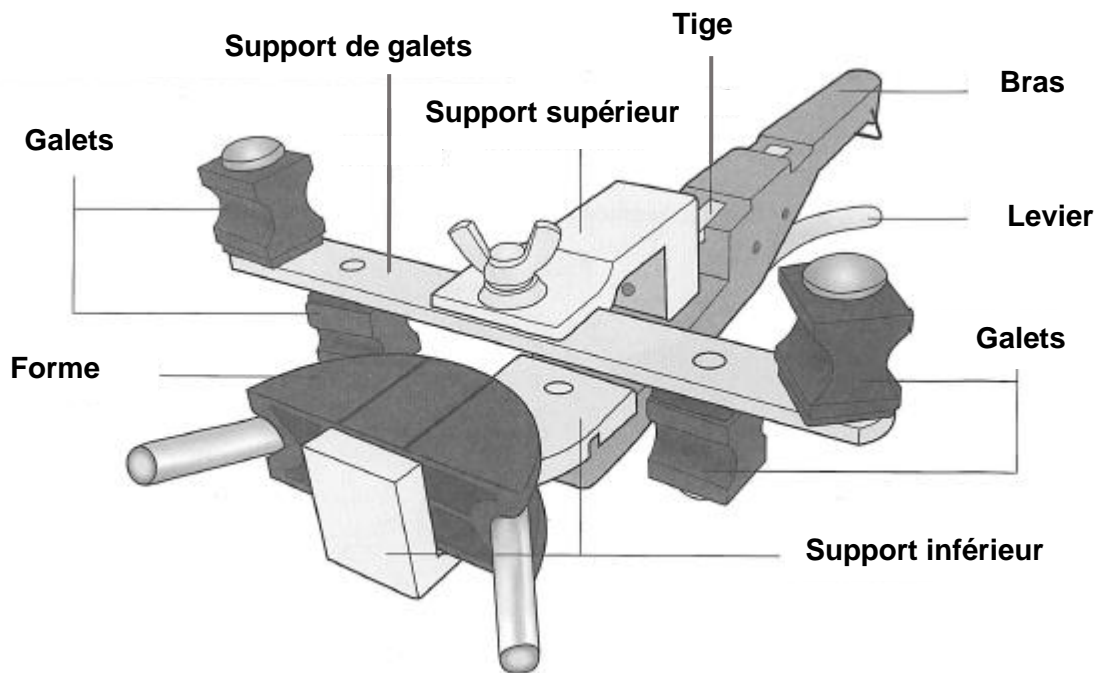

Relever le levier pour abaisser la tige.

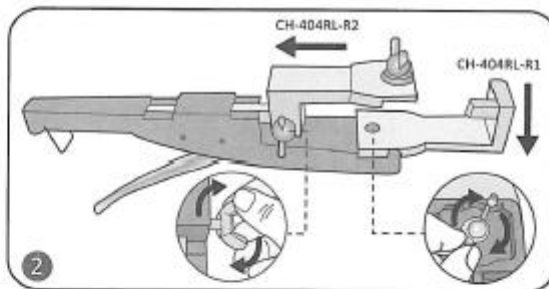

Mettre en place les supports inférieur et supérieur.

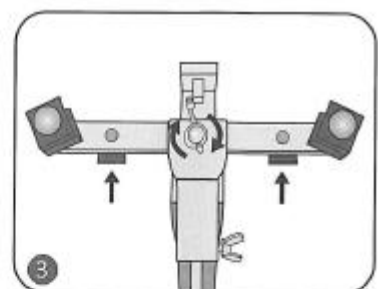

Mettre en place le support de galets.

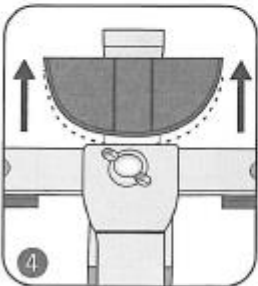

Ouvrir la cintreuse.

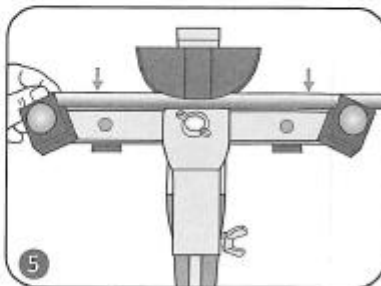

Mettre en place le tube, positionner les galets et amener la tige en butée.

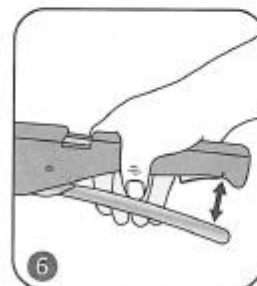

Procéder au cintrage.



Relever le levier pour libérer le tube.